



## industrial thermometer VMTh 110

Part no. 64108

industrial thermometer

### benefits

- extremely robust due to full metal housing
- vibration-resistant glass thermometer
- Stainless steel version possible
- excellent readability due to blue thermometer filling

### Application

Heating, industry, mechanical engineering

### Technical Specifications

**Nominal size**  
110 mm30 mm

**Upper part**  
Aluminium, V-shaped, polished, anodised brass-coloured. Numbers of measuring range printed in black at the right part of the scale below the anodised layer. Adjustable by means of brass nut (spanner size SW 22) so that readings from any angle are possible.

**Glass insert (capillary)**  
prismatic capillary, completely made of glass,  $\varnothing$  6 mm. Graduation marks of the capillary burnt in, black, completely resistant. Main graduation marks corresponding to the numbers printed on the housing are especially bold and easy to read.

**thermometer filling**  
Standard version: Blue liquid indicating from -60 to +200 °C.

### Options

- other ranges
- other stem lengths
- other stem materials

**Stem**  
brass,  $\varnothing$  10 mm, with fixed thread G $\frac{1}{2}$ B. Stainless steel version on request.

**accuracy**  
DIN 16195

**ranges °C**  
0/60

**mounting position**  
straight

**Immersion pipe length**  
100 mm

- other connection threads
- Upper part anodised aluminium-coloured
- Upper part made of plastic
- thermowells

**Technical Drawings**

mounting position straight

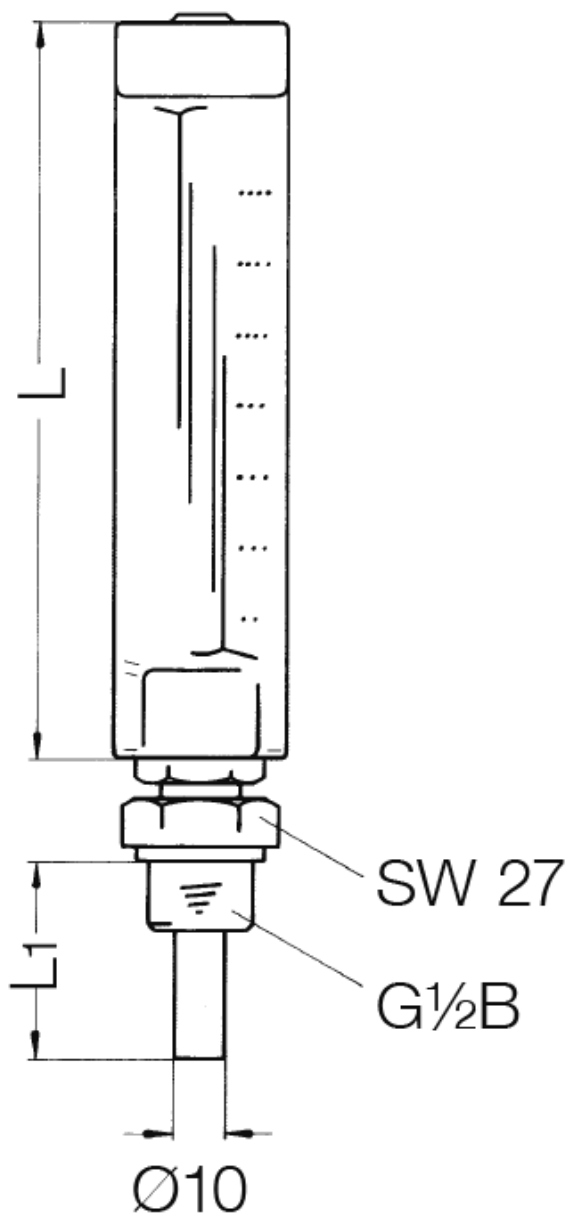

**Dimensions (mm)**

Typ	L			L <sub>1</sub>	
VMTh 110	110	40	63	100	160
VMTh 150	150	40	63	100	160
VMTh 200	200	40	63	100	160

## Versions

	Nominal size	Version	mounting position	Range	Stem length	Type		Part no.
VMTh 110	110 x 30 mm	DIN 16181	straight	0/60 °C	100 mm	VMTh 110	●	64108

● in-stock items

● Non-stock items