



Bourdon tube pressure gauges for chemical applications RF63Ch

Part no. 85123912

Bourdon tube pressure gauges for chemical applications Type D9

benefits

- for chemical and process engineering applications
- measuring system fully welded to housing
- extremely robust design
- for temperatures of the medium of up to 200 °C
- tightness-tested with helium
- GOSSTANDART-certified
- Ex version (optional)

Application

For corrosive gaseous and liquid media which are not highly viscous and do not crystallise; suitable for corrosive environments.
! For measuring gas or vapour, observe the table "Selection Criteria as per EN 837-2"!

Technical Specifications

Type

D9

Nominal size

63

accuracy class

EN 837-1/6

NG 63

1.6

ranges (EN 837-1/5)

see ordering table

application area

static load: $\frac{3}{4}$ x full scale value

dynamic load: $\frac{2}{3}$ x full scale value

short-term: Full scale value

Operating temperature range

NG 63

max. 200 °C

Ambient: -20/+60 °C

Temperature performance

Indication error when the temperature of the measuring system deviates from the normal temperature of 20 °C:
at rising temperature approx. ± 0.4 %/10 K
falling temperature approx. ± 0.4 %/10 K
of full scale value

Degree of protection

IP 65 (EN 60529)

Connection

Stainless steel 316 L, centre back

Measuring element

Bourdon tube, stainless steel 316 Ti/316 L
 ≤ 60 bar: "C" type tube
 > 60 bar: helical tube
tightness-tested with helium

movement

Stainless steel

Dial

Aluminium, white

Scaling: black

Pointer

Aluminium, black

Housing

Stainless steel 304, with blow-out

bayonet bezel

NG 63

crimped bezel

NG 63

Stainless steel 304

window

NG 63

Laminated safety glass

Options

- Brass movement
- Back flange (NG 63)
- clamp fixing
- Ex version
- Crimped bezel, polished
- special scales
- other process connections

Technical Drawings

NG 63 – centre back connection

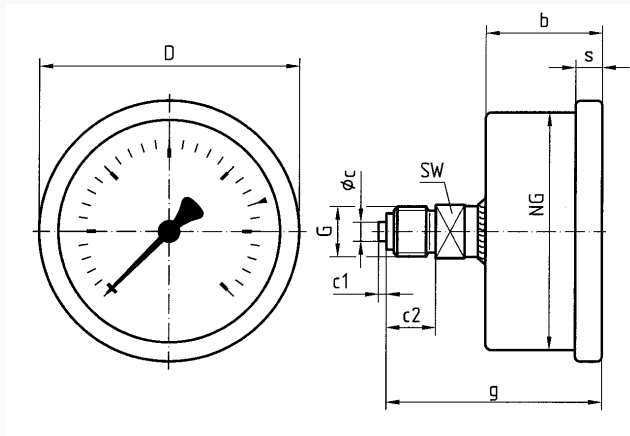

Dimensions (mm)

NG	b	∅c	c1	c2	D	G	g	s	SW
63	32	5	2	13	68	G¼B	56	7	14

Versions

Range	Mounting type	Type	Part number
0/400 bar	direct	RF63Ch D912	85123912

- in-stock items
- Non-stock items