

Bourdon tube pressure gauges for chemical applications RF50Ch

Part no. 85067932

Bourdon tube pressure gauges for chemical applications Type D9

benefits

- for chemical and process engineering applications
- measuring system fully welded to housing
- extremely robust design
- for temperatures of the medium of up to 200 °C
- tightness-tested with helium
- GOSSTANDART-certified
- Ex version (optional)

Application

For corrosive gaseous and liquid media which are not highly viscous and do not crystallise; suitable for corrosive environments.
! For measuring gas or vapour, observe the table "Selection Criteria as per EN 837-2"!

Technical Specifications

Type
D9

Nominal size
50

accuracy class
EN 837-1/6
NG 50
1.6

ranges (EN 837-1/5)
see ordering table

application area
static load: $\frac{3}{4}$ x full scale value
dynamic load: $\frac{2}{3}$ x full scale value
short-term: Full scale value

Operating temperature range

NG 50
max. 150 °C
Ambient: -20/+60 °C

Temperature performance

Indication error when the temperature of the measuring system deviates from the normal temperature of 20 °C:
at rising temperature approx. ± 0.4 %/10 K
falling temperature approx. ± 0.4 %/10 K
of full scale value

Degree of protection

IP 54 (EN 60529) with housing vent (≤ 25 bar)

Connection

Stainless steel 316 L, bottom back

Measuring element

Bourdon tube, stainless steel 316 Ti/316 L
 ≤ 60 bar: "C" type tube
 > 60 bar: helical tube
 tightness-tested with helium

movement

Stainless steel

Dial

Aluminium, white
 Scaling: black

Pointer

Aluminium, black

Housing

Stainless steel 304, with blow-out

bayonet bezel

NG 50
 Stainless steel 304

crimped bezel

NG 50

window

NG 50
 Plastic

Options

- Brass movement
- Back flange (NG 63)
- clamp fixing
- Ex version
- Crimped bezel, polished
- special scales
- other process connections

Technical Drawings

NG 50 – bottom back connection, 3-hole fixing, panel mounting bezel

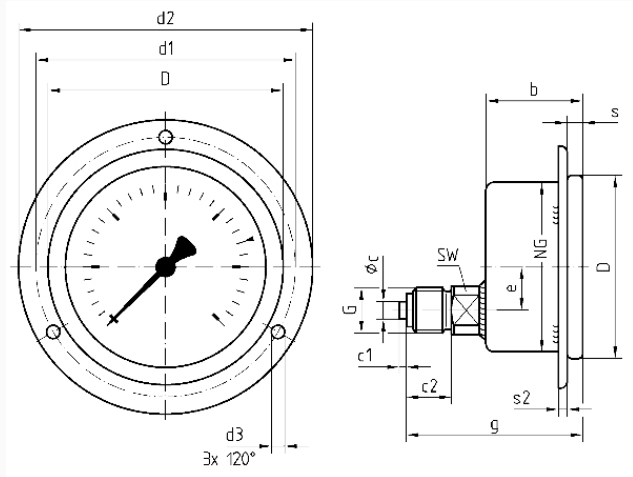

Dimensions (mm)

NG	b	∅c	c1	c2	d1*	d2*	d3*	D	e	G	g	s	s2	SW
50	28	5	2	13	60	70	3,6	53	12,5G	1/4B	51	4,5	2,5	14

* Dimensions as per DIN 16063

Versions

Range	Mounting type	Type		Part number
0/25 bar	3-hole fixing, panel mounting bezel	RF50Ch D932	●	85067932

- in-stock items
- Non-stock items