



Stainless steel diaphragm pressure gauges PF160E

Part no. 85938402

Stainless steel diaphragm pressure gauge type D4

benefits

- robust and compact design
- various process connections possible
- flush mounted versions without transmission liquid
- wetted area without seals due to welding
- GOSSTANDART-certified

Application

For corrosive gaseous and liquid media, also for use in corrosive environments. With open connection flange also suitable for viscous and polluted media; with hygienic connections specially suitable for pharmaceutical processes. For measuring gas or vapour, observe the table "Selection Criteria as per EN 837-2" (see appendix)!

Technical Specifications

Type
D4

Nominal size
160

accuracy class (EN 837-3/6)
1.6

ranges (EN 837-3/5)
see ordering table

application area
static load: Full scale value
dynamic load: 0.9 x full scale value

Overpressure safety
≥ 10 bar
max. 40 bar

Operating temperature range

Medium: max. 100 °C
Ambient: -20/+60 °C

Temperature performance

Indication error when the temperature of the measuring system deviates from the normal temperature of 20 °C:
at rising temperature approx. ± 0.8 %/10 K
falling temperature approx. ± 0.8 %/10 K
of full scale value

Degree of protection
IP 54 (EN 60529)

Connection
stainless steel 316 Ti/316 L, bottom
G½B, SW22 ()

lower measuring flange
stainless steel 316 Ti/316 L

upper measuring flange

Stainless steel 316 L

Measuring element

diaphragm

≥ 4 bar

Duratherm

movement

Stainless steel

Dial

Aluminium, white

Scaling: black

Options

- Glycerine filling (≥ 1 bar)
- wetted parts with special coating
- clamp connection
- Varivent or BioControl connection
- flush mounted connection flanges as per EN
- open connection flanges as per EN/ANSI
- Electrical contacts ($\geq 0/0.6$ bar)
- other connection threads

Pointer

Aluminium, black

Housing

Stainless steel 304, with blow-out

bayonet bezel

Stainless steel 304

window

Laminated safety glass

Technical Drawings

Bottom connection, 0/4 bar to 0/25 bar

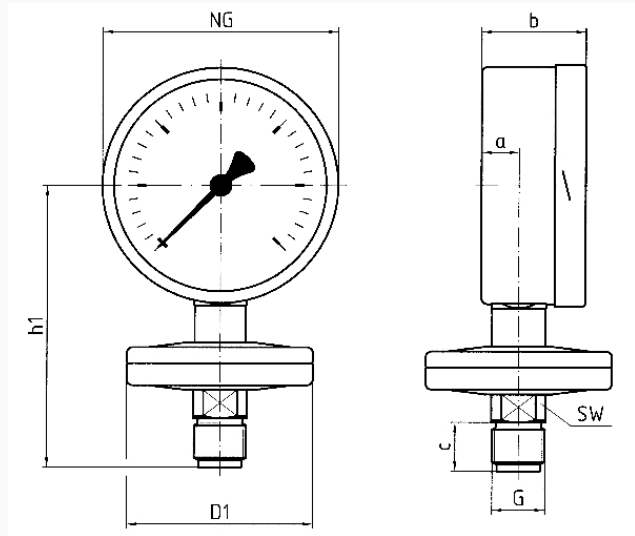

Dimensions (mm)

Dimensions (mm)

NG	a	b	c	D1	G	h1	SW
100	15,6	49	20	78	G½B	117	22
160	17,5	50	20	78	G½B	148	22

Versions

Range	Mounting type	Type	Part number
0/25 bar	direct	PF160E D402	85938402

- in-stock items
- Non-stock items