



Resistance thermometers WTh 27

Part no. 32262

Resistance thermometers

benefits

- suitable for use in mechanical engineering, plant engineering, process engineering chemical industry
- resistance thermometer with Pt100 sensor
- flange connection
- Wetted parts 316 Ti

Application

Flange-type resistance thermometer for medium pressure and flow loads

Technical Specifications

Sensor

1 x
3-wire
Class B, IEC 751

Measuring insert

replaceable
Diameter: 6 mm

Thermowell

Ø 11 x 2 mm
Stainless steel 316 Ti

Neck

Ø 11 x 2 mm
Length: 120 mm
Stainless steel 316 Ti

Process connection

flange as per EN 1092-1 type B 1
Stainless steel 316 Ti
Nominal diameter: DN 20
Nominal pressure: PN 40

Installation length

250 mm

Connection head

Type B As per DIN 43729
aluminium die cast

Electrical connection

Cable gland

Degree of protection

IP 54 (EN 60529)

Measuring range

-35/+400 °C

Options

- Sensor class A
- reduced measuring tip (6 mm)
- Transmitter installation
- other thermowell materials
- other process connections
- other installation lengths
- other connection heads

Technical Drawings

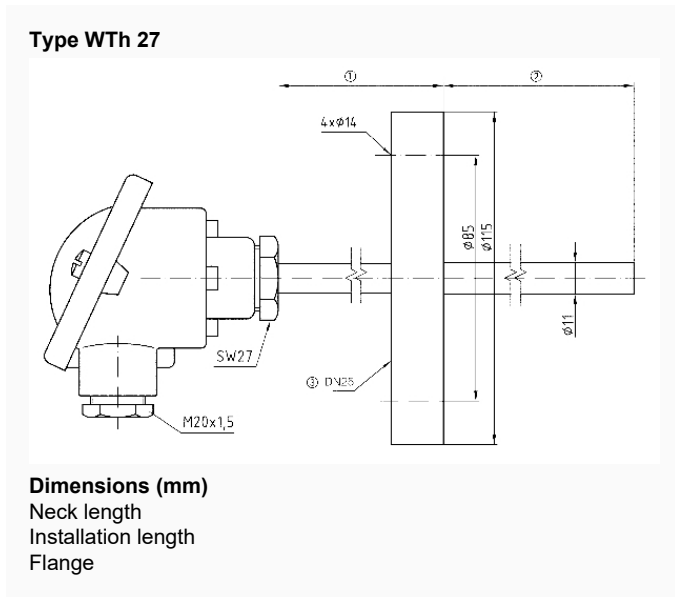

Versions

	Installation length	Part no.
Resistance thermometers WTh 27	250 mm	32262

- in-stock items
- Non-stock items