



capacitance level switch CapFox® ENT 21 MK -10 HT

Part no. 5656010HT-L-3B01

capacitance level switch

benefits

- easy adjustment via magnetic pin
- IP 68 degree of protection
- for temperatures of the medium of up to 300 °C
- EX version suitable for mining

Application

For level detection of conductive and non-conductive liquids in tanks, ducts, pipes or silos. Particularly suitable for application in the food, pharmaceutical and chemical industries. Also ideal for level detection of bulk solids such as sand, gravel, cement and granular material stored in open or closed containers.

Description

The capacitance level switch CapFox® ENT 21 consists of an electronics module integrated in a robust stainless steel housing and the measuring electrode. The electrode is partially or fully insulated; in conjunction with a conductive tank wall or an earthed counter-electrode, it forms a capacitor whose capacitance depends on the electric characteristics of the environment. As soon as the dielectric (electric field) is no longer formed by a air or a another gas (free electrode), but by a liquid or the bulk solids, the capacitance changes. This is converted into a switching signal by the electronics. An NPN or a PNP transistor output is available as electrical output. The sensor output of the EX version complies with EN 60947 (NAMUR).

Fully or partially insulated rigid probes or flexible probes are available, depending on the medium and the application. Only fully insulated electrodes are used for level detection of adhesive, corrosive or electrically conductive media.

Technical Specifications

Indicator

LED green: Operation
LED orange: status

Process connection

¾" NPT

material

Housing: Stainless steel 304
MK

Supply voltage

DC 7 – 34 V
load current: max. 300 mA

Switching point adjustment

Adjustment via magnetic pin, included

Current input

max. 5 mA without load

Degree of protection

IP 68 (EN 60529)

Electrical connection

Cable gland M12 x 1.5 with fixed cable connection

Cable length: 2 m

Options

- other process connections
- FEP/PFA coatings
- Ex version
- Ex II 1 G Ex ia IIB T6 Ga
- Ex II 1 D Ex ia IIIC T80°C Da
- Ex I M1 Ex ia I Ma
- HT EX version
- Ex II 1/2 G Ex ia IIB T6 Ga/Gb
- Ex II 1/2 D Ex ia IIIC T80°C Da/Db

Weight

HT version

ca. 0.6 kg

Scope of delivery

- CapFox® ENT 21 according to configuration
- magnetic pin

Technical Drawings

CapFox® ENT 21 MK - 05/10 compact probe with PPS partial insulation

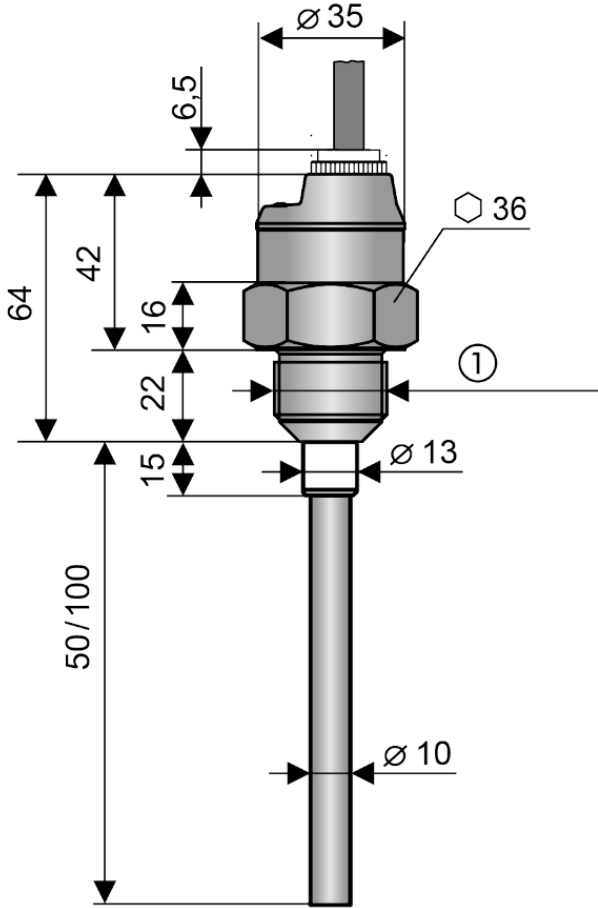

Dimensions (mm)
Process connection

Versions

	model / series	Process connection	Output signal	Part no.
CapFox® ENT 21 MK	CapFox® ENT 21 MK -10 HT	3/4" NPT	3-wire PNP	5656010HT-L-3B01

- in-stock items
- Non-stock items